

Article number: 2310431045S

Description: E+G Levelling elements
LX.40-SW17-M10X62-S

Measures

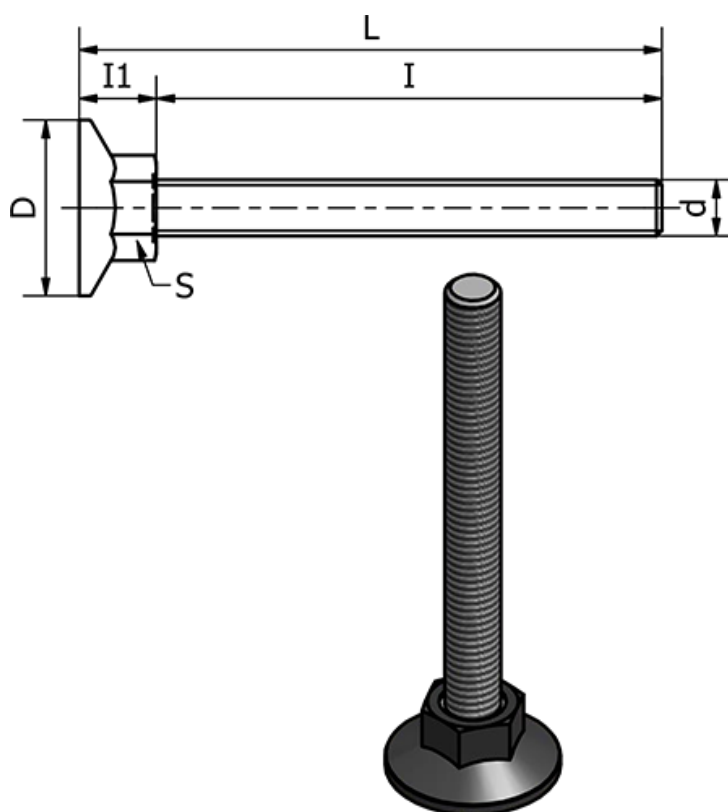

d	= M10
D	= 40
I	= 62
I1	= 13
L	= 74.5
S	= 17
Static load in (N)	= 3000
Type	= Forzinket

Weight (g) = -